

# Data Sheet

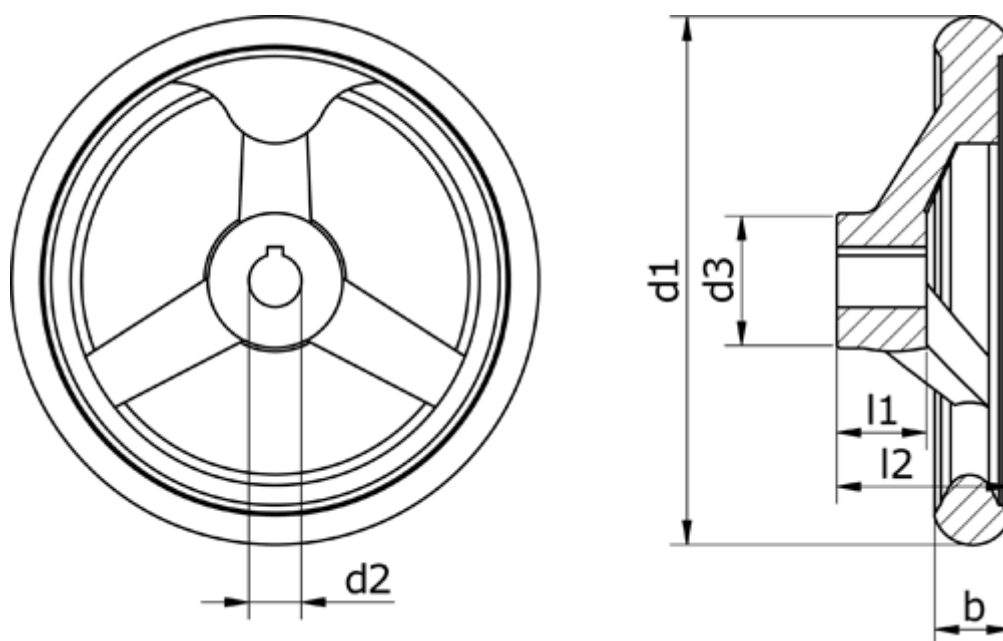

Article number: 201575332  
Description: E+G Handwheel  
GN 950.6-200-K18-A

## Measures



b1 = 20.0  
d1 = 200  
d2 = 18  
d3 = 37.0  
d4 = M10  
l1 = 24  
l2 = 44.5